



Mesures

Fiche 1

Les masses

1

Je colorie l'objet le plus lourd quand c'est possible.

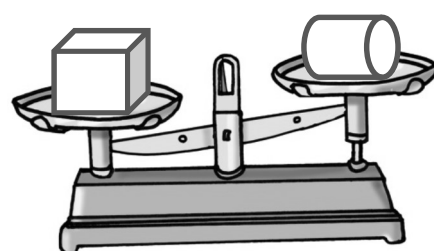
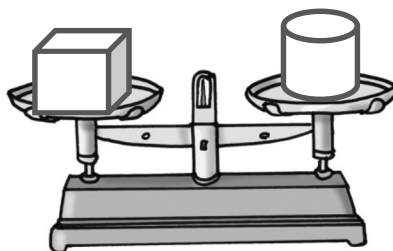
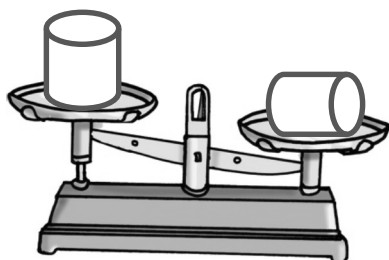
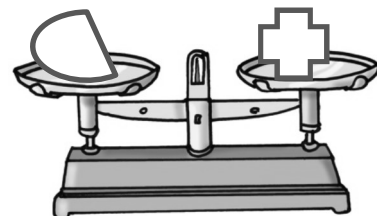
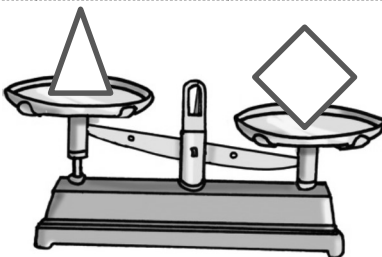
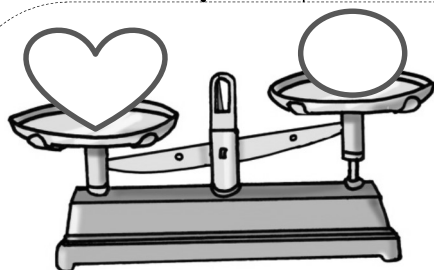

2

J'entoure la bonne réponse.

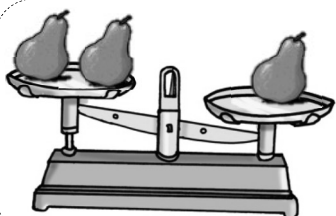

possible

impossible

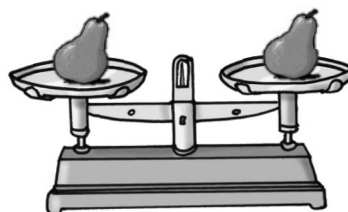

possible

impossible

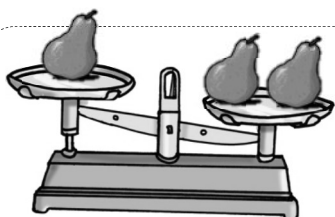

possible

impossible

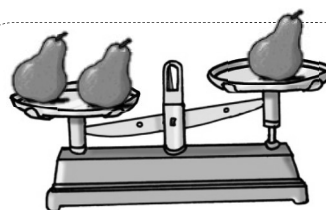

possible

impossible

3

Je complète les plateaux vides en dessinant des pommes.

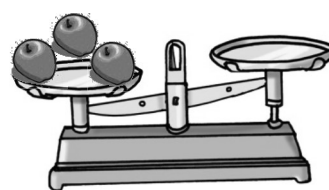
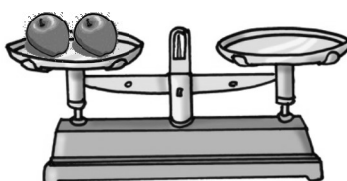
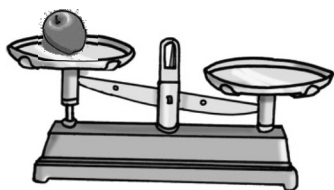



Mesures

Fiche 2

Les masses

1 Je colorie l'objet le plus léger quand c'est possible.

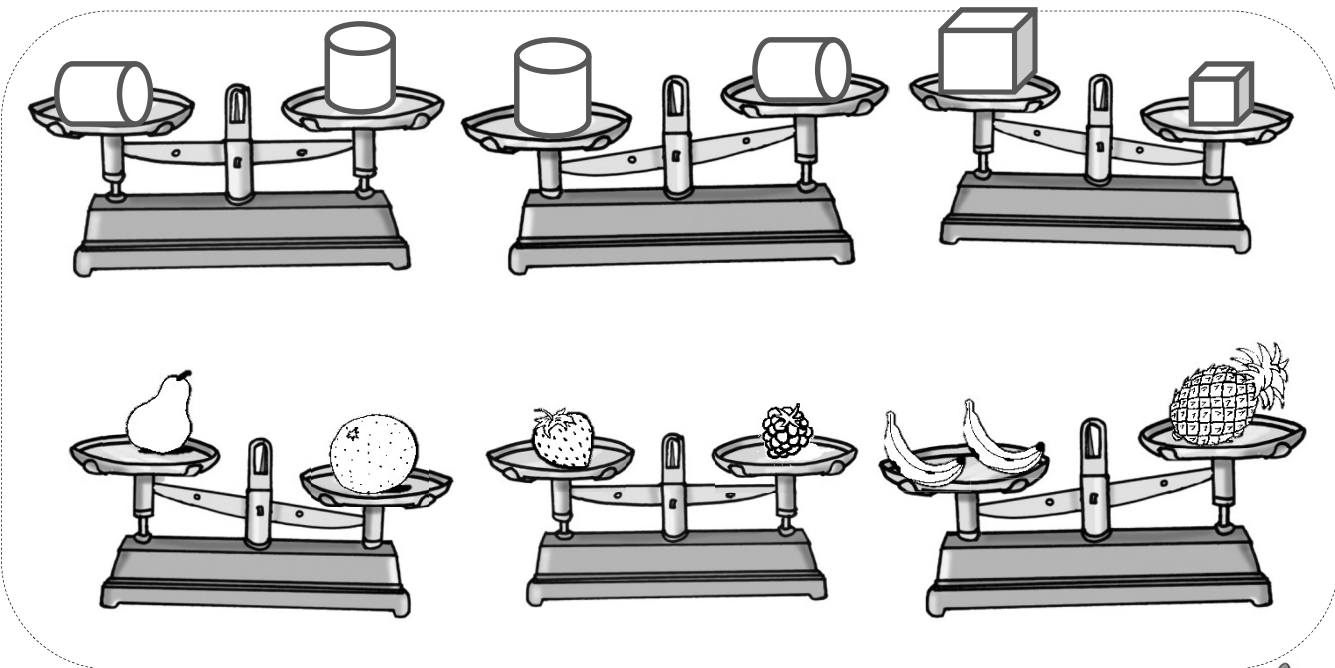

2 J'entoure la bonne réponse.

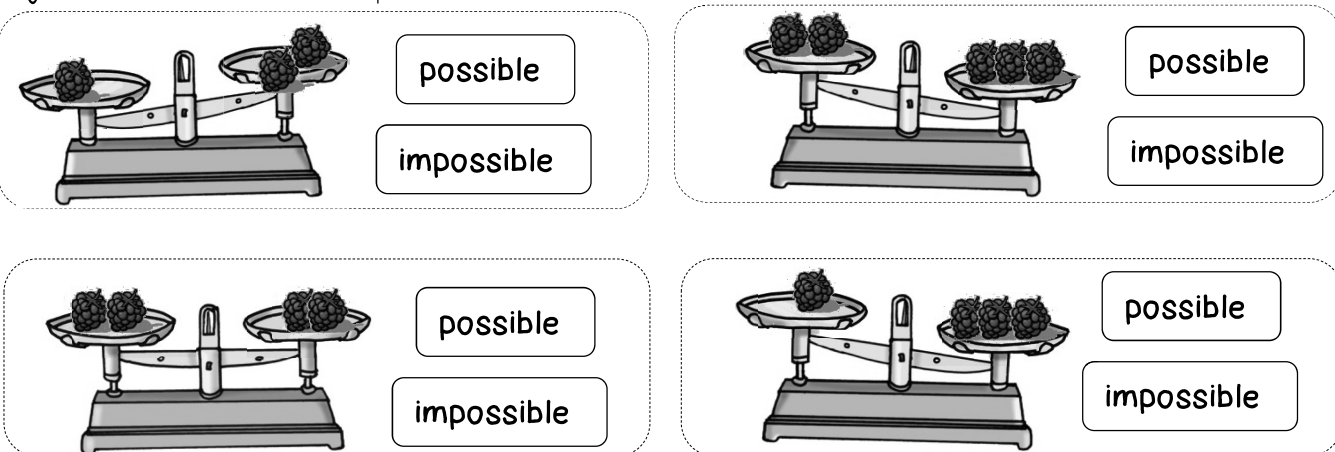

3 Je complète les plateaux en dessinant des oranges pour que la balance soit juste.

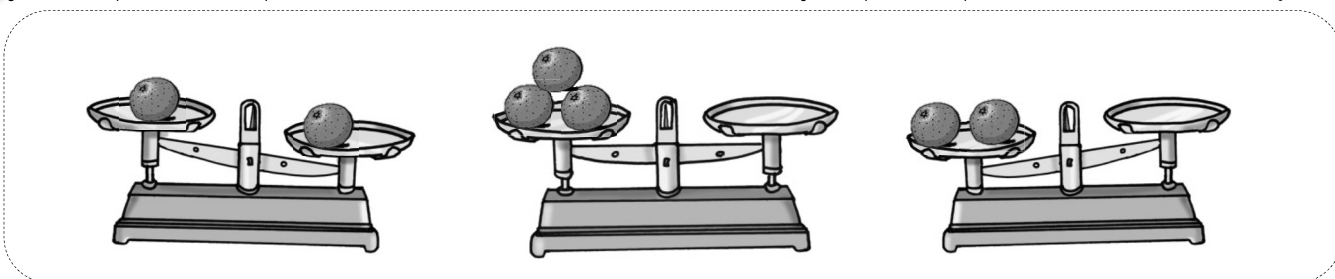



Mesures

Fiche 3

Les masses

1 Je colorie la bonne réponse.

	g	kg		g	kg		g	kg
	g	kg		g	kg		g	kg

2 J'entoure la masse la plus vraisemblable.

Une baguette de pain	800 g	1 kg	250 g
Un bébé	8 g	3 kg	25 kg
Une pièce de 2€	3 kg	7 g	100 g
Un homme	80 kg	10 g	750 g



3 Je classe les enfants du plus léger au plus lourd.

Je pèse 35 kg.



Lise

Je pèse 40 kg.



Luc

Je pèse 25 kg.



Lilou

Je pèse 28 kg.



Louis

--	--	--	--

Qui pèse 10 kg de moins que Lise ?











Mesures

Fiche 4

Les masses

1 Je colorie la bonne réponse.

 <input type="checkbox"/> g <input type="checkbox"/> kg	 <input type="checkbox"/> g <input type="checkbox"/> kg	 <input type="checkbox"/> g <input type="checkbox"/> kg
 <input type="checkbox"/> g <input type="checkbox"/> kg	 <input type="checkbox"/> g <input type="checkbox"/> kg	 <input type="checkbox"/> g <input type="checkbox"/> kg

2 Je calcule la masse de chaque objet.

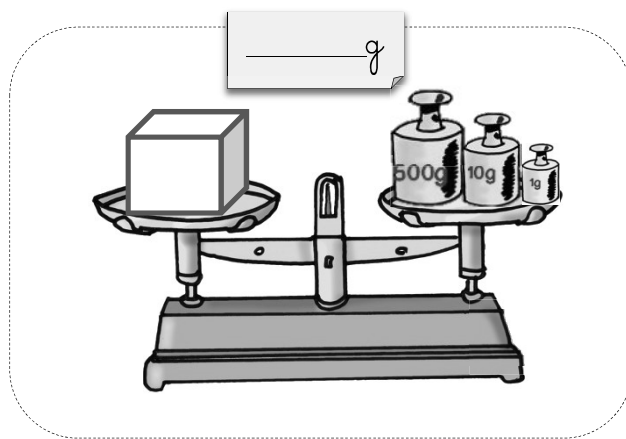
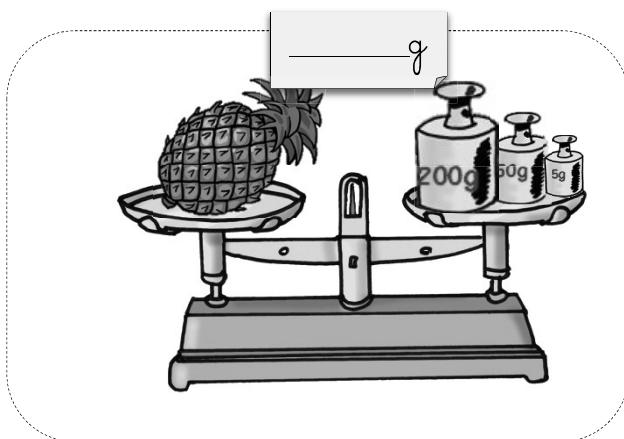
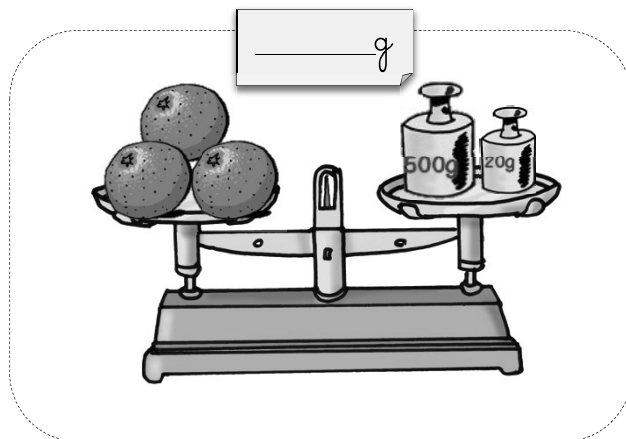
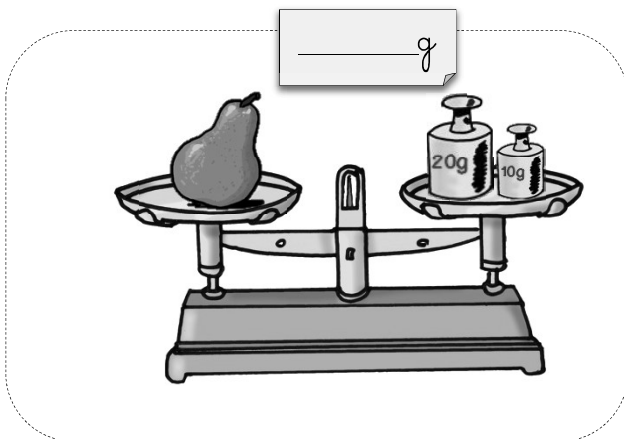
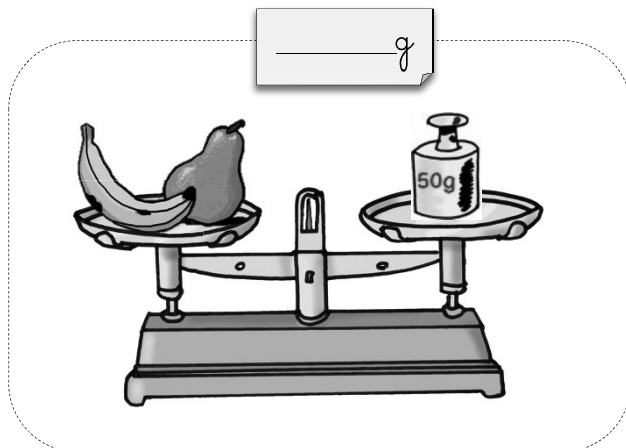
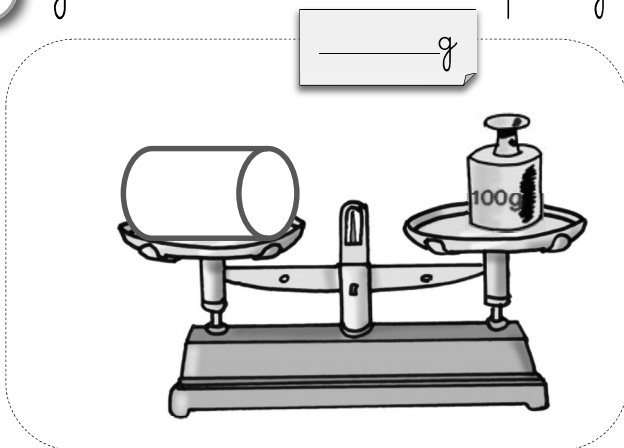



Mesures

Fiche 5

Les masses

1

Je calcule la masse du plateau et je la note dans l'autre plateau.

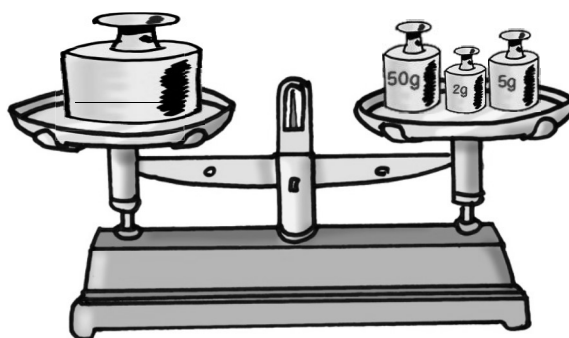
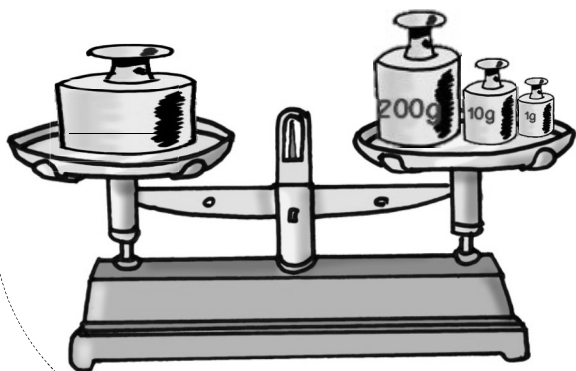
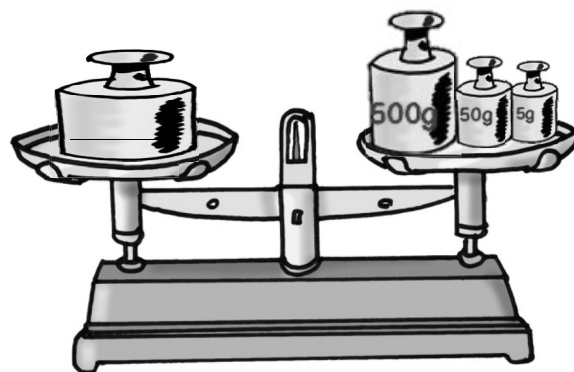
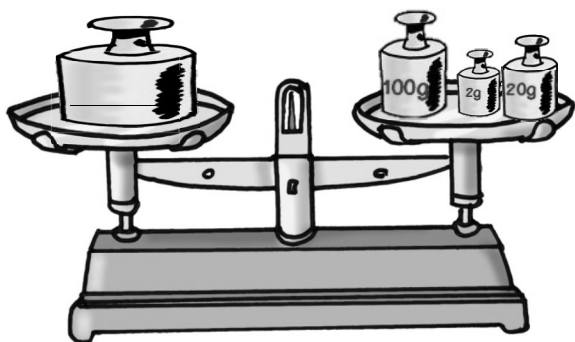
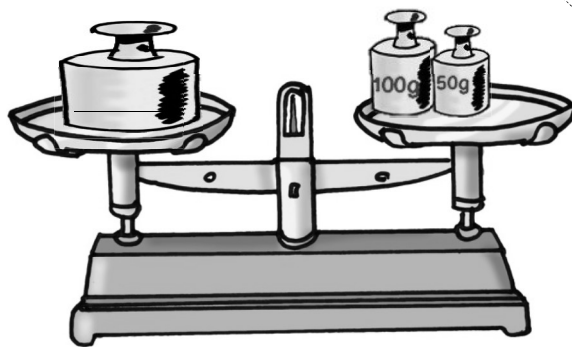
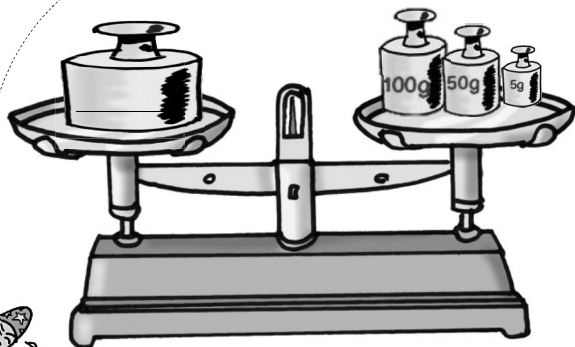

2

Je trouve la masse du plateau.

